

Elite Acoustics Engineering D6-8 Live-Performance Studio Monitor with 6 Channels, Digital Mixer & Effects, and Bluetooth®

Quick Guide Handbook version v1.00f

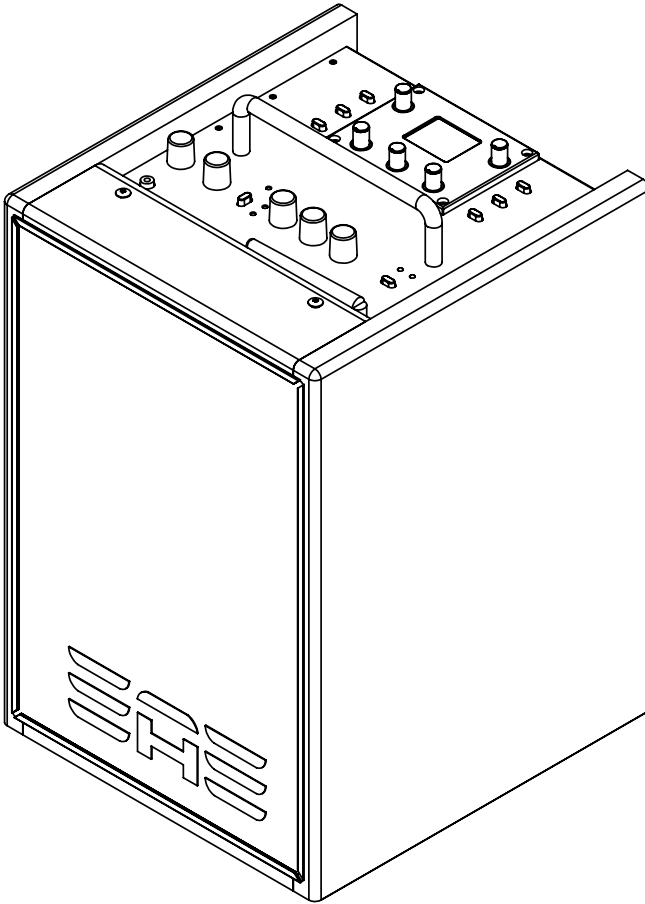

WHAT IS IN THE BOX

Your D6-8 package contains the following:

- | | |
|---------------------------------------|---|
| (1) Speaker | (1) Quick Start Guide & Registration Card |
| (1) AC to 12VDC Power Supply Adapter | (1) Speaker Handle Grip |
| (1) 12V DC Car Battery Supply Adapter | |

The Bluetooth word mark and logos are registered trademarks owned by Bluetooth SIG, Inc. and any use of such marks by Elite Acoustics Designs, Inc is under license

NOTE: Due to continuous development and improvements of our products, features and specifications are subject to change without notice. All weights and measures are approximate.

For a copy of the complete User's Manual, please visit: www.eliteacoustics.com

D6 is the most comprehensive portable sound system currently produced; D6 offers extreme versatility without compromise. Our designers have incorporated a full featured programmable Digital Mixer with Effects and Custom Display into our legendary A4 sonic platform. This combination of incredible clarity and studio quality sound reproduction with all the features of professional production is unprecedented. A highly intuitive UI with extensive dedicated parameter control empowers any discerning artist to unleash studio-quality performances in any venue. Additionally, D6 stores and manages your parameter settings allowing instant access to that perfect mix. Simply put, D6 is unrivaled in performance and versatility.

QUICK START MIC AND ACOUSTIC GUITAR

In this example we connect an acoustic guitar to Chan 1, and a Mic to Chan 2.

1. Set Battery Switch to “Connect”
2. With “Speaker Volume” turned down, Turn “Power Switch” to “On” position.
3. Connect the Line Level Output of your acoustic guitar into Chan 1, Line 1/4” input jack. Note: Chan 1 Source is set to “Mic/Line.”
4. Connect your Mic to Chan 2, XLR input jack. Note: Chan 2 Source is set to “Mic/Line.”
5. Set input levels. Press “System”; the LCD shows a level bar graph for each channel. Adjust rear panel “Gain” control until the display shows -12dB for Guitar and Mic.
- 5A. Adjust Master Volume for desired output level.
6. Set Mic Mix, EQ, and Reverb.
- 6A. Press “Main” adjust chan 2 encoder to +9, i.e., approximately 75% of max level.
- 6B. Press Chan 2 Encoder: LCD shows EQ parameters for Chan 2. Adjust 5 encoders as necessary to set your EQ. For our example we’ll set “LowC” to 180 Hz, “Low” to +4.0, “Mid” to +5, “MidF” to 2.0k and “Hi” to +2.0.
- 6C. Press “Reverb” Chan 2 encoder +2.0.
7. Repeat step 6 for Chan 1 (acoustic guitar) Mix, EQ, and Reverb.
8. Start with master EQ, Low, Mid, and High set flat (detent position) and adjust as needed.

LCD FUNCTIONS

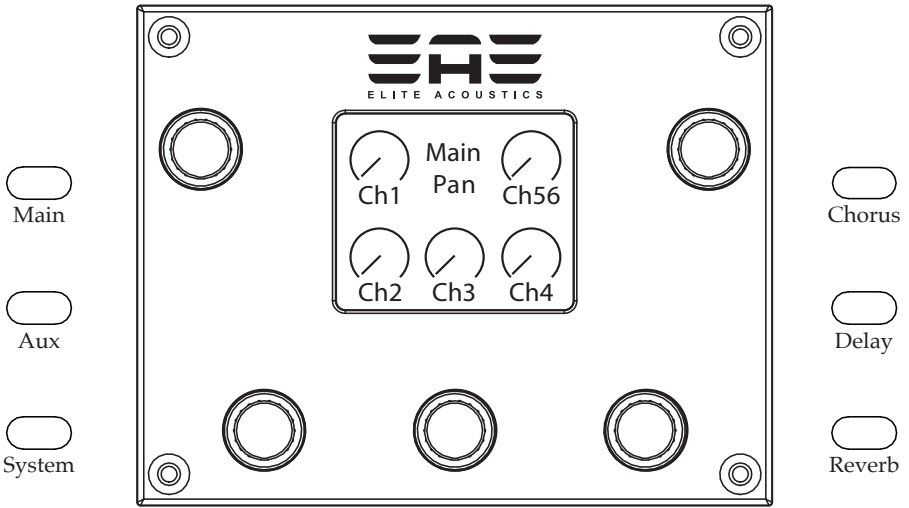

Menu Buttons with LCD:

Press any of the 6 menu buttons (black button located to the left and right of LCD) or 5 encoders (blue knobs located around LCD) to access and adjust features and settings. Most menus have several pages of options, which are adjusted by turning the corresponding encoder.

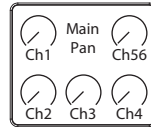
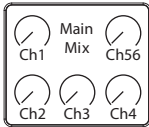

“Main” Page 1: “Main Mix”
Adjust the level of each of the 5 channels.

“Main” Page 2: “Main Pan”
Adjust the stereo panning for each of the 5 channels.



“Aux” : “Aux Mix” Adjust the level of each of the 5 channels sent to the Aux Outputs.

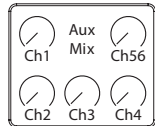

“Aux” : “Aux Pan” Adjust the panning between “Aux Send 1” and “Aux Send 2” for each of the 5 channels.

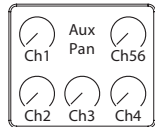

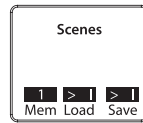
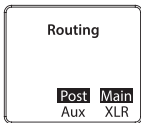

“System” : “Routing”

Assign “Pre” or “Post” fader i.e., “Main Mix” Channel 1 through Channel 6, signals to the Aux Sends. You can also select either “Main” mix or “Aux” mix as the source for the XLR outputs.

“System” : “Scenes”

Save and Recall up to 10 mixes i.e., scenes.

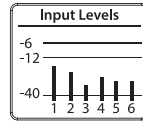
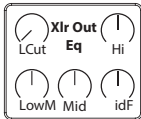

“System” : “XLR out EQ”

Setting for EQ for the XLR outputs when it is SET on “MAIN outputs”

“System” : “Input Levels”

Displays a bar graph for each channel’s input level. Adjust the channel’s “Gain” pot to set desired level.

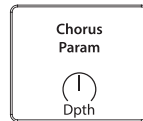
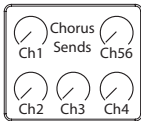

“Chorus” : “Chorus Sends”

Adjust the Chorus level of each of the 5 channels.

“Chorus” : “Chorus Param”

Adjust the Depth of the Chorus for each of the 5 channels.

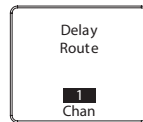
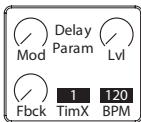

“Delay” : “Delay Param”

Adjust “Modulation,” “Feedback,” “Time Offset,” “BPM” Delay Time, and “Level” of the delay.

“Reverb” : “Delay Routes”

Assign a channel to the delay. Note that this is an “insert” type effect and is intended for a selectable single channel. It precedes the Reverb and Chorus effects.

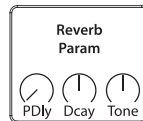
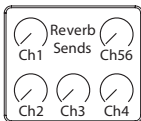

“Reverb” : “Reverb Sends”

Adjust the Reverb level of each of the 5 channels.

“Reverb” : “Reverb Param”

Adjust the Decay and Tone of the Reverb.

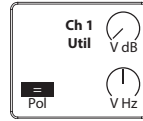
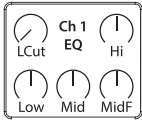

“Encoder Select” (press to enable):
“Ch 1 EQ”
 Adjust the EQ settings for which ever channel is selected. (Chan 1- 5/6)

“Encoder Select” (press to enable):
“Ch 1 UTIL
 Adjust Phase and Notch Filter level/ Freq. settings for channel selected. (CHAN 1 to CHAN 4)

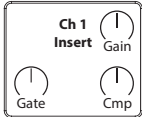

“Encoder Select” (press to enable):
“Ch 1 Insert”
 Adjust the Insert settings for the selected channel (Ch.1-4). Note: this includes Gain and Threshold settings as well as an independent Noise Gate.

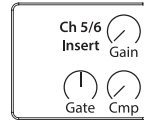

“Encoder Select” (press to enable):
“Ch 5/6 Insert”
 Adjust the Insert settings for Channel 5/6. Note: this includes Gain and Threshold settings as well as an independent Noise Gate.

REFERENCE DIAGRAM

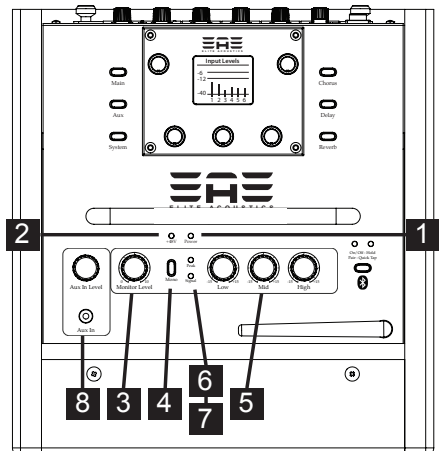
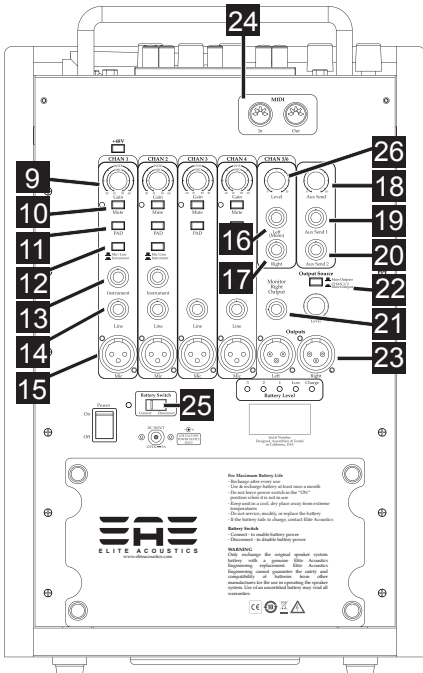

Refer to Reference Diagram in previous page for features listed below

Power LED:

BLUE [1]: Indicate unit is ON

+48V LED [2]: Indicates Phantom Power is on

Monitor Output Controls

Speaker Volume [3]: Control speakers' volume level

Mono [4]: Changes speaker output to Mono sound

Equalizer [5]: Adjust High, Mid, and Low Frequency response

Peak LED [6]: RED indicate Signal Clip

Signal LED [7]: GREEN indicate Signal Present

Aux Input/Level [8]: Connect audio source with 1/8" jack from MP3/CD player

Channel 1

Gain [9]: Gain level control

Mute [10]: Mute Channel

PAD [11]: Fixed attenuation to reduce input level

Source[12]: Select Mic/Line or Instrument input

Instrument In [13]: 1/4" TRS inputs

Line In [14]: 1/4" TRS inputs

Mic In [15]: XLR for Microphone Input

Channel 2

Gain [9]: Gain level control

Mute [10]: Mute Channel

PAD [11]: Fixed attenuation to reduce input level

Source[12]: Select Mic/Line or Instrument input

Instrument In [13]: 1/4" TRS inputs

Line In [14]: 1/4" TRS inputs

Mic In [15]: XLR for Microphone Input

Channel 3

Gain [9]: Gain level control

Mute [10]: Mute Channel

PAD [11]: Fixed attenuation to reduce input level

Line In [14]: 1/4" TRS inputs

Mic In [15]: XLR for Microphone Input

Channel 4

Gain [9]: Gain level control

Mute [10]: Mute Channel

PAD [11]: Fixed attenuation to reduce input level

Line In [14]: 1/4" TRS inputs

Mic In [15]: XLR for Microphone Input

Channel 5/6

Level [26]: Level control

Left (Mono) [16]: 1/4" balance TRS input

Right [17]: 1/4" balance TRS input

Aux

Aux Send Level [18]: Aux output level control

Aux Send 1 [19]: 1/4" balance TRS output

Aux Send 2 [20]: 1/4" balance TRS output

Monitor Output: Connect with extra speakers/monitors

Monitor Right Output [21]: Connect to another speaker using 1/4" TRS

Output Source [22]: Select either Main Mix or Direct Output for Chan 1 & 2

Main Output [23]: XLR Left/Right Output

MIDI: MIDI IN/OUT [24]: 5 PIN DIN connectors for MIDI controllers

Battery Switch[25] : Battery Slide Switch to preserve battery life for storage or transit

Connect: Enable battery power when using unit

Disconnect: Disable battery power when storing unit to preserve battery life

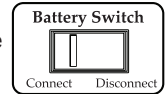

BLUETOOTH® FUNCTION

- To turn ON/OFF Bluetooth® function
PRESS/HOLD down MODE button for approximately 5 seconds
Both LEDs will flash at the same time
- To pair device to the speaker system
Bluetooth® needs to be turned ON
QUICK TAP the MODE button once
Both Flashing LED: indicate Bluetooth® is ready to be paired
Flashing Blue LED only: indicate Bluetooth® is connected

TO FULLY CHARGE SPEAKER SYSTEM

1. Put power switch in the "OFF" position and Battery Switch in the "Connect" position
2. Plug in power adaptor into the DC input jack
3. Blue "Charge" LED will turn on, indicating the speaker is charging
4. When the speaker is fully charged, the blue "Charge" LED will turn off

FOR MAXIMUM BATTERY LIFE

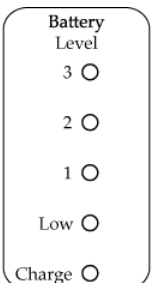

- Recharge after every use
- Use & recharge battery at least once a month
- DO NOT leave power switch in the "ON" position when it is not in use. Doing so after a long period of time will damage the battery
- Keep unit in a cool, dry place away from extreme temperatures
- Do not service, modify, or replace the battery
- If the battery fails to charge, contact Elite Acoustics Designs

WARRANTY

Elite Acoustics Engineering Inc. warrants this product to be free of defects in material and workmanship (excluding battery) for a period of 1 year from the date of original retail purchase. Elite Acoustics Engineering Inc. warrants the Speaker's Battery for 90 days from the date of original retail purchase. This warranty is enforceable only by the original retail purchaser. To be protected by this warranty, the purchaser must complete and return the enclosed warranty card within 14 days of purchase. During the warranty period EAE shall, as its sole and absolute option, either repair or replace, free of charge, any product that proves to be defective on inspection by EAE or its authorized service representative. To obtain warranty service, contact Elite Acoustics Engineering Technical Support via email: RMA@eliteacoustics.com. **PRE-AUTHORIZATION MUST BE OBTAINED BEFORE SENDING ANY PRODUCT TO AN ELITE ACOUSTIC ENGINEERING SERVICE CENTER.** All inquires must be accompanied by a description of the problem. All authorized returns must be sent to the EAE repair facility postage prepaid, insured and properly packaged. EAE reserves the right to update any unit returned for repair. EAE reserves the right to change or improve the design of the product at any time without prior notice. This warranty does not cover claims for damage due to abuse, neglect, alteration, or attempted repair by unauthorized personnel and is limited to failures arising during normal use that are due to defects in material or workmanship in the product. Any implied warranties, including implied warranties of merchantability and fitness for a particular purpose, are limited in duration to the length of this limited warranty. Some states do not allow limitations on how long an implied warranty lasts, therefore the above limitation may not apply to you. In no event will EAE be liable for incidental, consequential, or other damages resulting from the breach of any express or implied warranty, including among other things, damage to property, damage based on inconvenience or on loss of use of the product, and, to the extent permitted by law, damages for personal injury. Some states do not allow the exclusion of limitation of incidental or consequential damages, so the above limitation or exclusion may not apply to you. This warranty gives you specific legal rights, and you may also have other rights, which vary from state to state. This warranty only applies to products sold and used in the United States of America. For warranty information in all other countries please refer to your local distributor.

©Elite Acoustics Engineering Inc.

SYSTEM SPECIFICATIONS

- **System Architecture** : Ultra high-speed high-capacity DSP with lossless A/D and D/A conversion. Integrated Digital Mixer supports routing and seamless signal-level management for five fully configurable audio channels. Color Graphic LCD presents a highly intuitive GUI for settings, save & recall, and MIDI functionality.
- **Digital Effects and Controls**: Channel Parametric EQ, Notch Filter, Compressor, Noise Gate, Main and Aux panning, Reverb, Chorus, Delay, Real-Time Chan-Level Bar Graphs, Save & Recall Programs.
- **Analog Master controls**: Master Volume, Mono Switch, Equalizer (Low, Mid, High)
- **Speakers**: 8" Woofer; 1" Silk-dome Tweeter
- **Amplifier**: Class D Bi-AMP
- **Nominal output levels (1 kHz)**: Right Channel Link out: -10 dBu Main/Direct Output: +4dBu
- **Stereo Inputs**: 1/4" Left/Right input jacks
- **Phantom Power**: +48V
- **Aux in control**: Level knob
- **Displays**: Color Graphic LCD; signal, peak, sys power, phantom power, and batter level LEDs
- **Connectors**: **CH1 & 2**: Input jacks (mic XLR, 1/4" Line, 1/4" Instrument), **CH3/4**: (mic XLR, 1/4" Line), **CH5/6**: Left/Right stereo input (1/4" TRS), **AUX in**: (1/8" jack), Right channel output (1/4"), XLR Direct Out (Chan 1 & 2) or Main Mix outputs, DC in jack
- **Power Switch**
- **Power Supply**: DC 12V
- **Built-in rechargeable SLA battery with battery meter**: approximately 6 to 8 hrs play time with full charge
- **Current Draw**: 5000 mA
- **Other features**:
 - Playback from Bluetooth device
 - Optimized front ports for extended low-frequency response
 - Magnetic shielding eliminates interference with other electronic equipment
 - Rechargeable Battery can be recharged from Car battery when using DC car adaptor cord that is included
 - Built-in pole-mount, 35mm receptacle on bottom of unit
- **Accessories**: AC cord, AC adaptor, DC cord for the car, Owner's manual
- **Dimensions**: 10.90"L x 10.25"W x 16.40"H
- **Weight**: 28 lbs

For a copy of the complete User's Manual, please visit: www.eliteacoustics.com